

## SURFACE MOUNTED

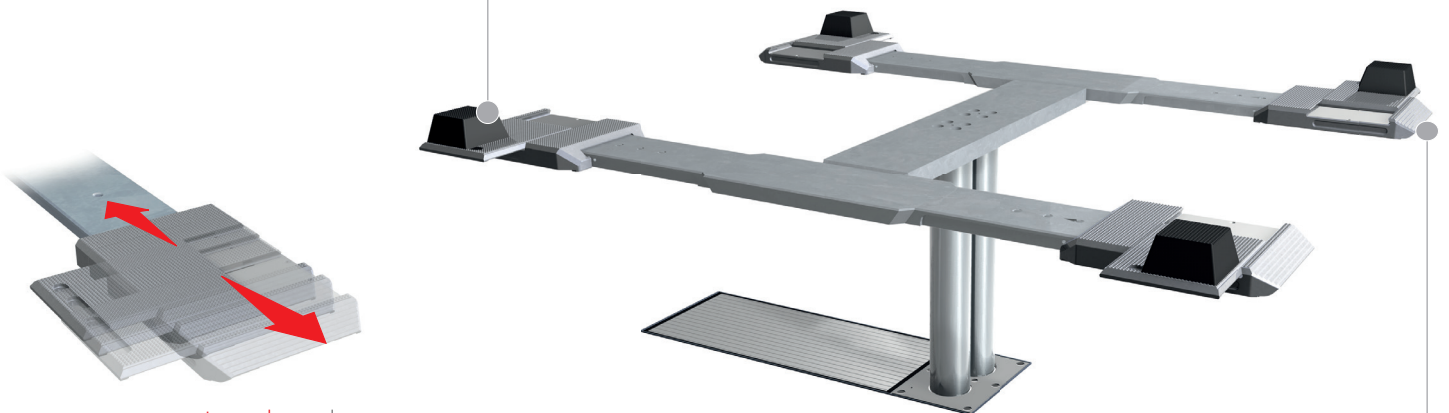

Rubber pad pyramid 70 mm  
102273 (optional accessories)



Length and crosswise  
adjustable aluminum  
slider plates

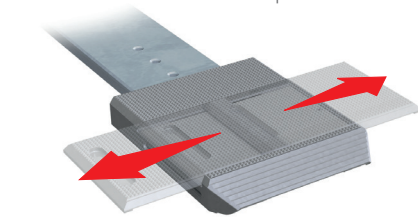

Drive over height  
only 60 mm

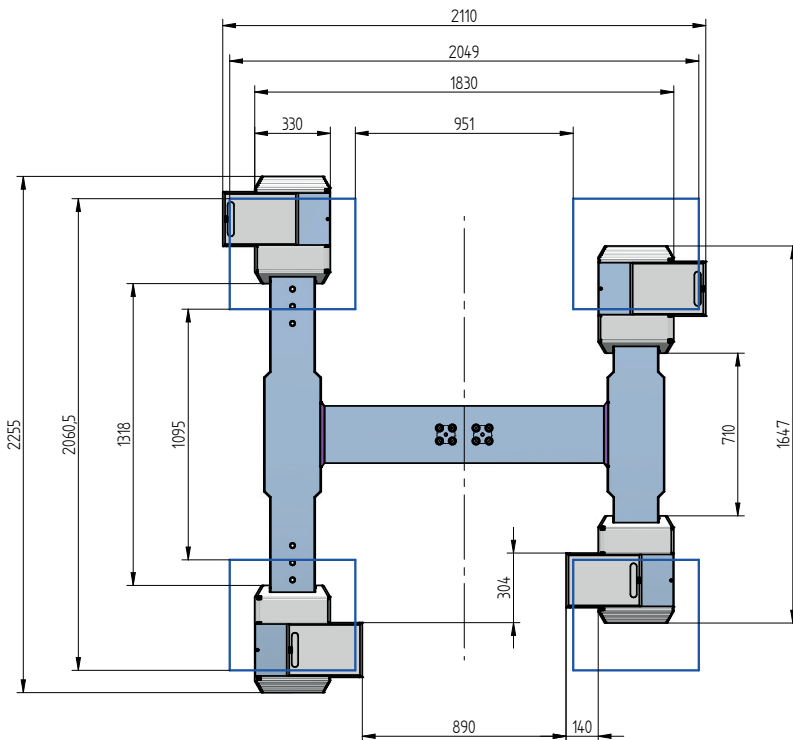

## TECHNICAL DATA

Capacity	3500 kg
Effective raise height	2045 mm
Drive over height	60 mm
Piston diameter	123 mm
Installation depth	2408 mm
Motor output	3,0 kW
Power connector	400 V/16 A
Cable length to control	11 m
Lifting time	≈ 35 sec.
Lowering time	≈ 35 sec.

Support Uni 1.35 DZ H plus midi galvanized	112320
Installation cassette STEEL 1-piston DZ	2040XX
Installation cassette STEEL 1-piston DZ galvanized	2041XX
Lifting unit oil 3,5 t 1-piston DZ - K pre-assembled in installation cassette	110077
Lifting unit oil 3,5 t 1-piston DZ - H packed in wooden box	110125



## ACCESSORIES

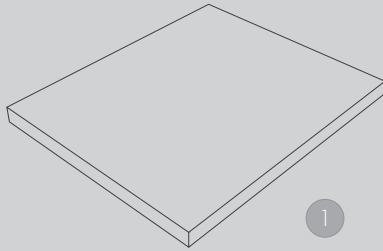

1

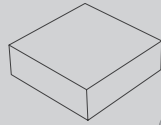

2

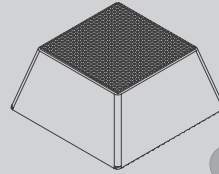

3

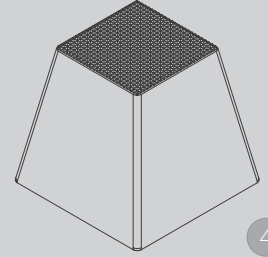

4

1 | Rubber pad  
290 x 335 x 20 mm  
102275 (1 Set / 4 Pieces)

2 | Rubber pad  
120 x 120 x 40 mm  
102274 (1 Set / 4 Pieces)

3 | Rubber pad pyramid  
70 mm  
102273 (1 Set / 4 Pieces)

4 | Rubber pad pyramid  
140 mm  
102291 (1 Set / 4 Pieces)

**Herrmann AG**  
Bahnhofstrasse 32  
D-93483 Pöding

Phone: +49 (0)9461/91388 50  
E-Mail: [sales@herrmann-lifts.com](mailto:sales@herrmann-lifts.com)

[www.herrmann-lifts.com](http://www.herrmann-lifts.com)