

SURFACE MOUNTED

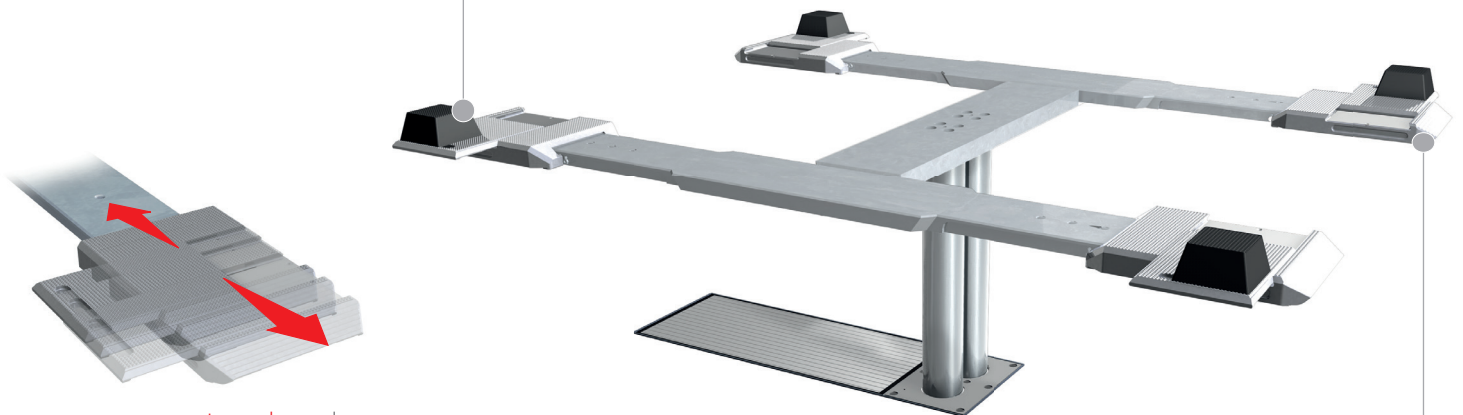

Rubber pad pyramid 70 mm
102273 (optional accessories)



Length and crosswise
adjustable aluminum
slider plates

Drive over height
only 60 mm

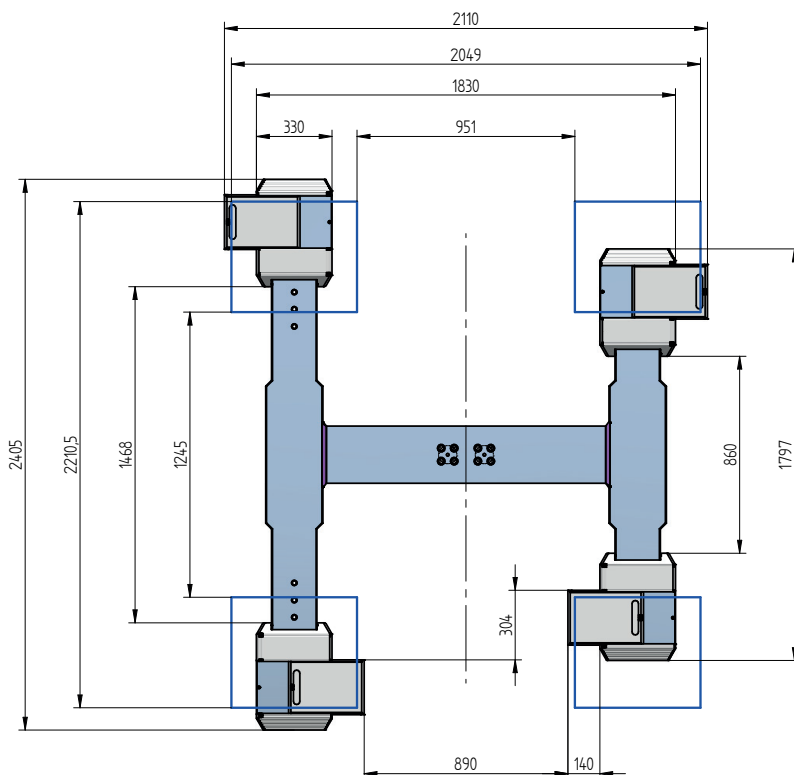
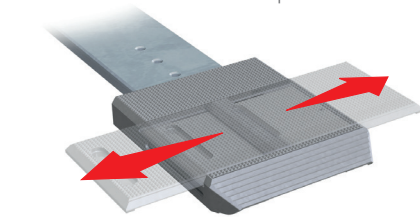

TECHNICAL DATA

Capacity	3500 kg
Effective raise height	2045 mm
Drive over height	60 mm
Piston diameter	123 mm
Installation depth	2408 mm
Motor output	3,0 kW
Power connector	400 V/16 A
Cable length to control	11 m
Lifting time	≈ 35 sec.
Lowering time	≈ 35 sec.

Support Uni 1.35 DZ H plus maxi galvanized	11231
Installation cassette STEEL 1-piston DZ	2040XX
Installation cassette STEEL 1-piston DZ galvanized	2041XX
Lifting unit oil 3,5 t 1-piston DZ - K pre-assembled in installation cassette	110077
Lifting unit oil 3,5 t 1-piston DZ - H packed in wooden box	110125

ACCESSORIES

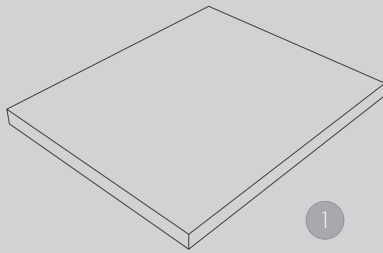

1

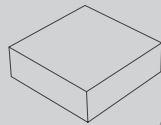

2

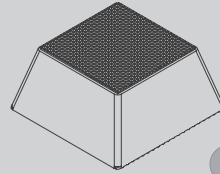

3

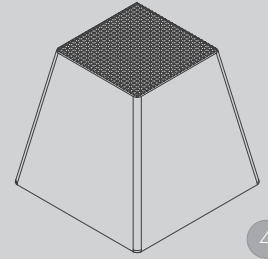

4

1 | Rubber pad
290 x 335 x 20 mm
102275 (1 Set / 4 Pieces)

2 | Rubber pad
120 x 120 x 40 mm
102274 (1 Set / 4 Pieces)

3 | Rubber pad pyramid
70 mm
102273 (1 Set / 4 Pieces)

4 | Rubber pad pyramid
140 mm
102291 (1 Set / 4 Pieces)

Herrmann AG
Bahnhofstrasse 32
D-93483 Pöding

Phone: +49 (0)9461/91388 50
E-Mail: sales@herrmann-lifts.com

www.herrmann-lifts.com