

SURFACE MOUNTED

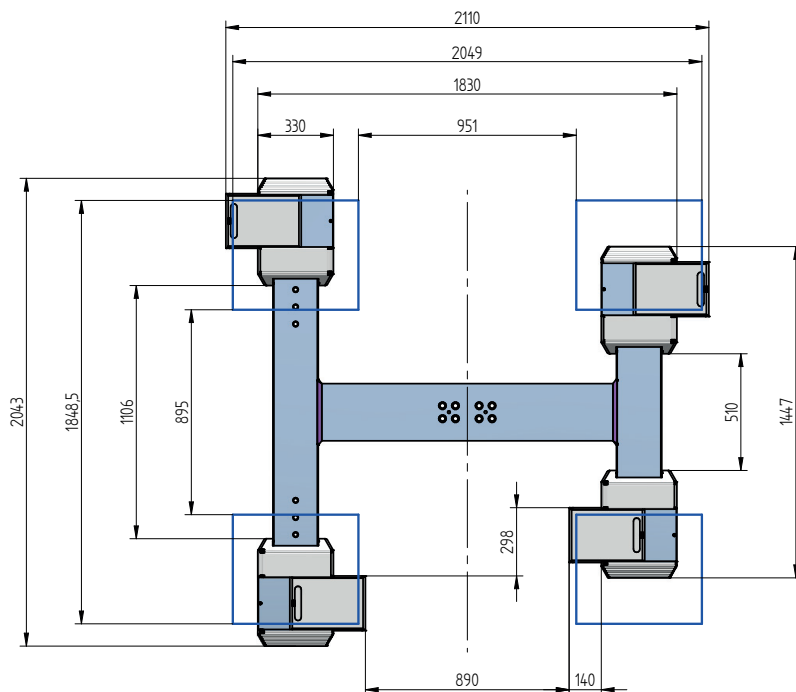
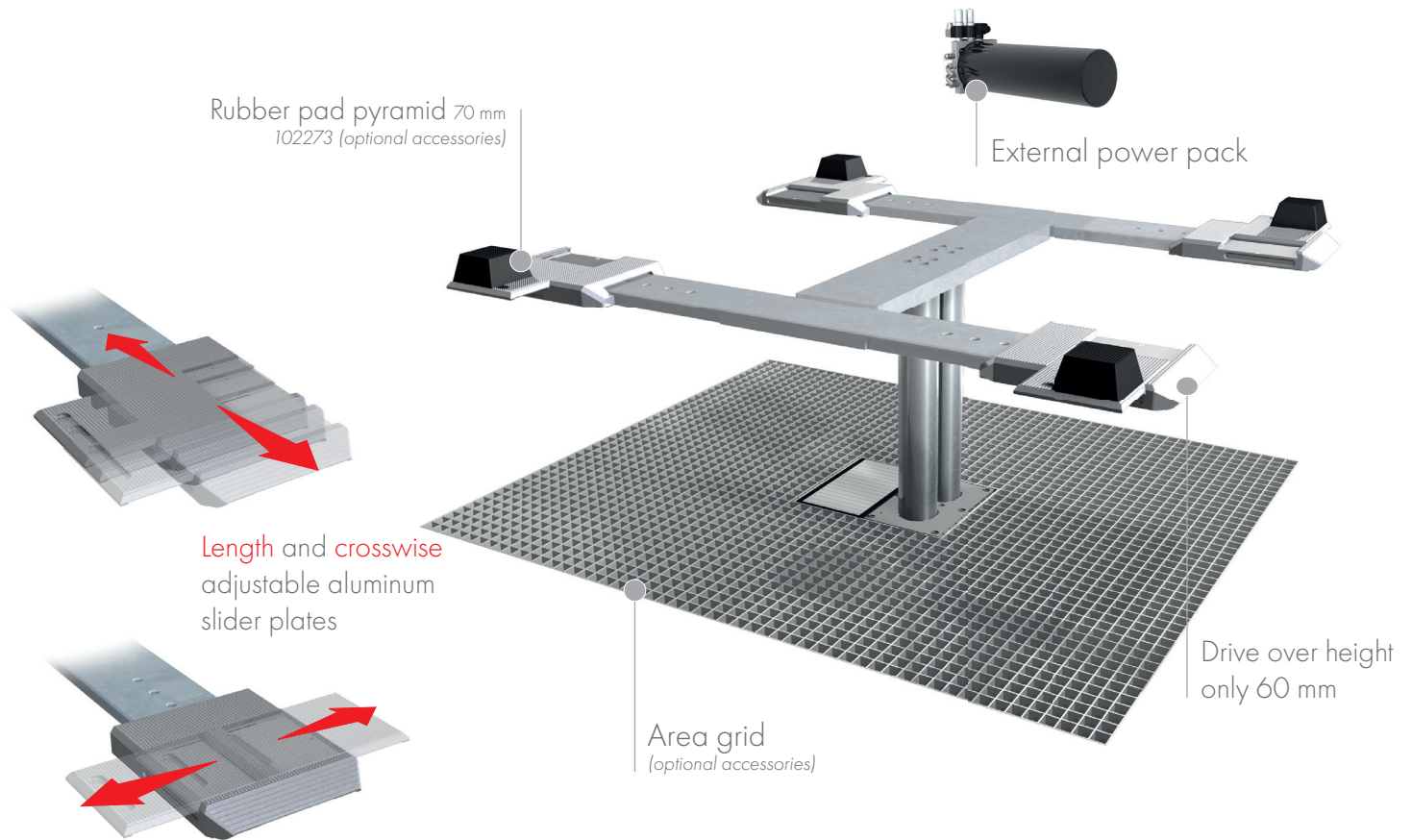

TECHNICAL DATA

Capacity	3500 kg
Effective raise height	2045 mm
Drive over height	60 mm
Piston diameter	123 mm
Installation depth	2408 mm
Motor output	3,0 kW
Power connector	400 V/16 A
Cable length to control	11 m
Lifting time	≈ 35 sec.
Lowering time	≈ 35 sec.

Support Uni 1.35 DZ H plus galvanized	112319
Installation cassette STEEL 1-piston DZ	2040XX
Installation cassette STEEL 1-piston DZ galvanized	2041XX
Lifting unit oil 3,5 t 1-piston DZ - K pre-assembled in installation cassette	110126
Lifting unit oil 3,5 t 1-piston DZ - H packed in wooden box	110127



ACCESSORIES

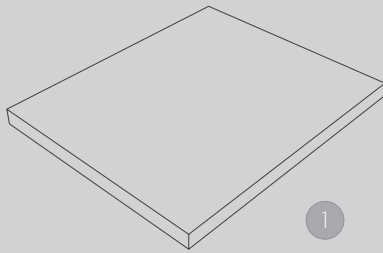

1

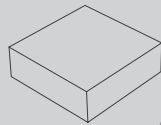

2

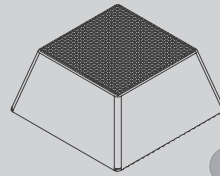

3

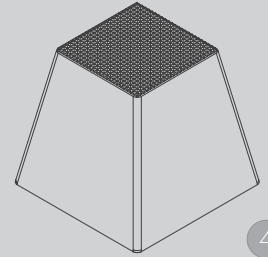

4

1 | Rubber pad
290 x 335 x 20 mm
102275 (1 Set / 4 Pieces)

2 | Rubber pad
120 x 120 x 40 mm
102274 (1 Set / 4 Pieces)

3 | Rubber pad pyramid
70 mm
102273 (1 Set / 4 Pieces)

4 | Rubber pad pyramid
140 mm
102291 (1 Set / 4 Pieces)

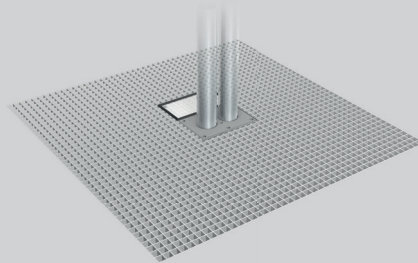

Area grid
4000 x 2400 mm
110217



Cover for external
power pack and control
110190

Herrmann AG
Bahnhofstrasse 32
D-93483 Pöding

Phone: +49 (0)9461/91388 50
E-Mail: sales@herrmann-lifts.com

www.herrmann-lifts.com