

SURFACE MOUNTED

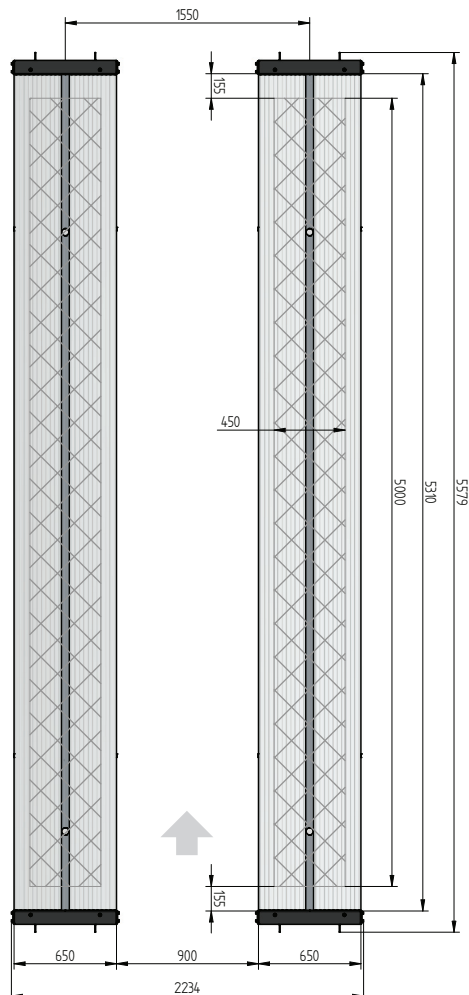
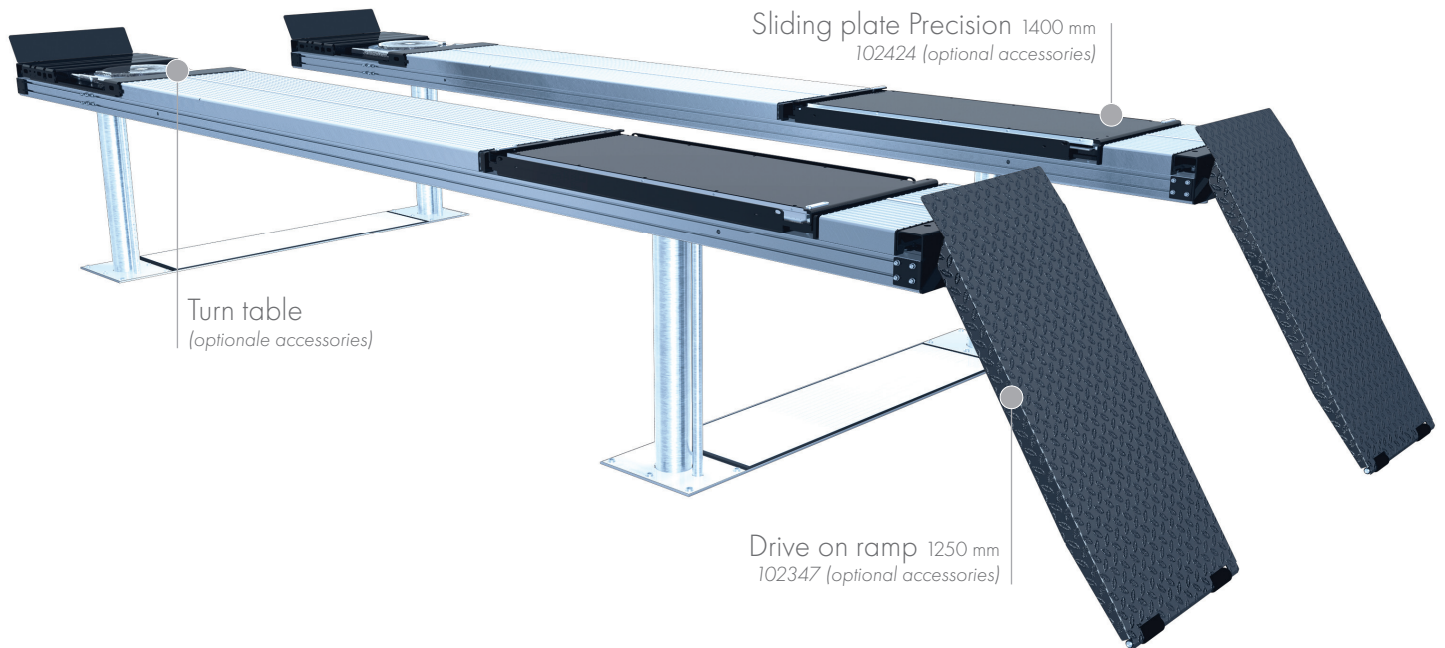

TECHNICAL DATA

capacity	6500 kg
effect. raise height	2008 mm
platform length	5500 mm
platform height	180 mm
piston diameter	123 mm
piston distance	1550 mm
installation depth	2443 mm
motor output	3,0 kW
power connector	400 V/16 A
cable length to control	11 m
lifting time	≈ 35 sec.
lowering time	≈ 35 sec.

Platform support Alu Track 4.65 with platform notches for turn tables and sliding plates	108619
Platform support Alu Track 4.65 with platform notches for joint play tester	108618
Platform support Alu Track 4.65	108617
Installation cassettes STEEL 1550 mm	2420XX
Installation cassettes STEEL 1550 mm galvanized	2421XX
Lifting unit oil 6,5 t 1550 mm - K pre-assembled in installation cassette	111609
Lifting unit oil 6,5 t 1550 mm - H packed in wooden box	111610

ALU TRACK 4.65

ACCESSORIES

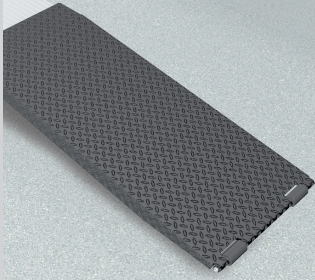

Drive on ramp
1250 mm
102347

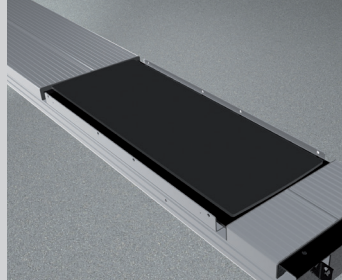

Sliding plate
Precision 1400 mm
102424

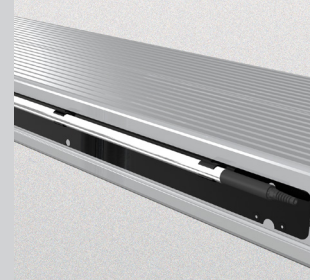

Lighting
LED
111598

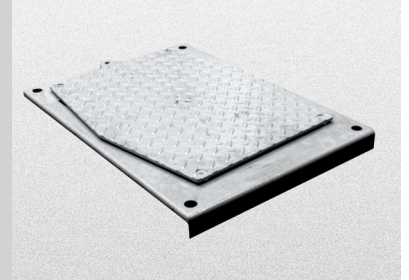

Joint play tester
108613

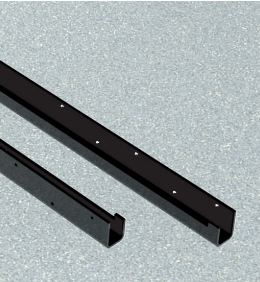

Slide rail
5500 mm
102376

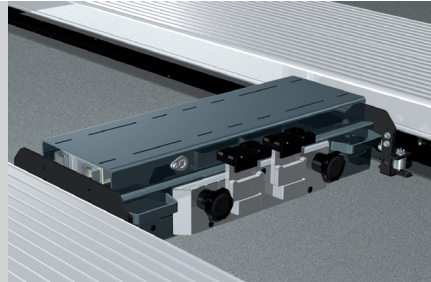

Axle lifter 2600 kg
pneumatic, without slide rails
105063

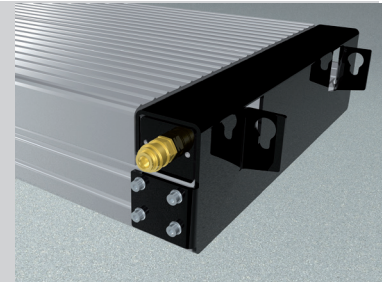

Compressed air supply
105617

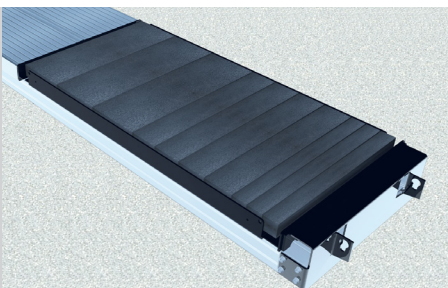

Rubber elements
50 mm 100 mm 200 mm
111677 111678 111679

Herrmann AG
Bahnhofstrasse 32
D-93483 Pöding

+49 (0)9461/91388 50
sales@herrmann-lifts.com
www.herrmann-lifts.com