

SURFACE MOUNTED

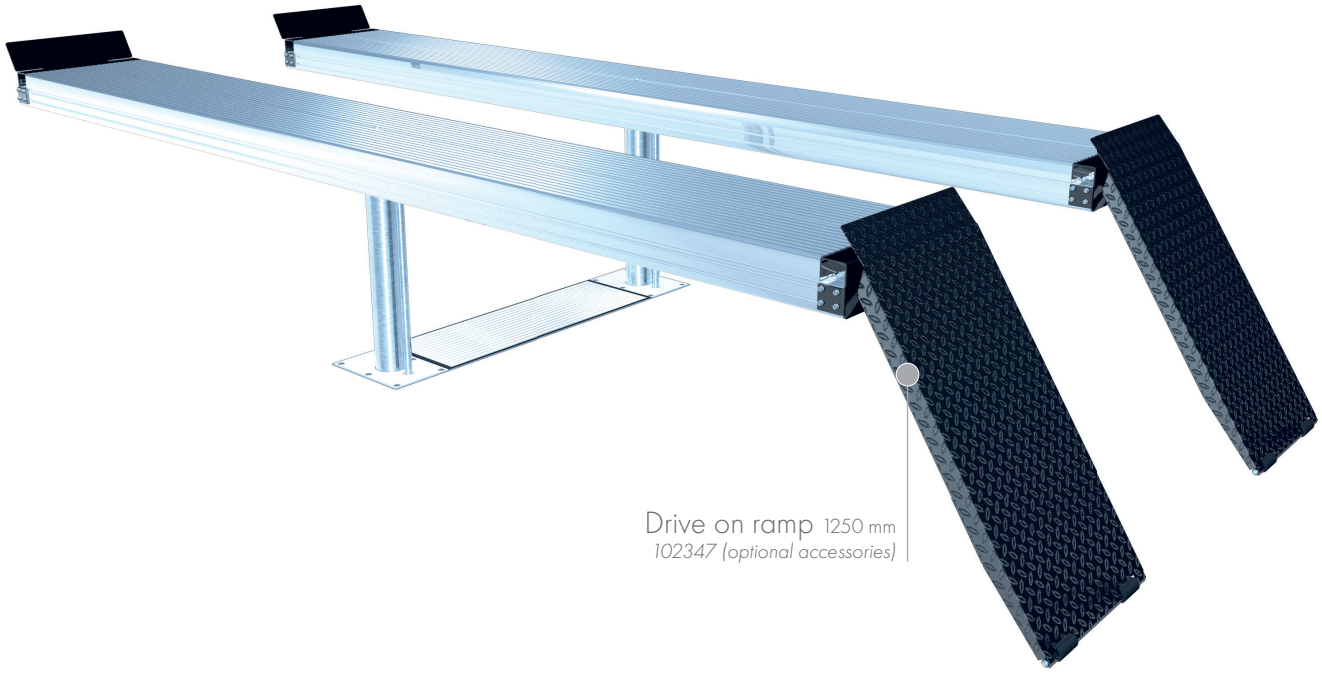

Drive on ramp 1250 mm
102347 (optional accessories)

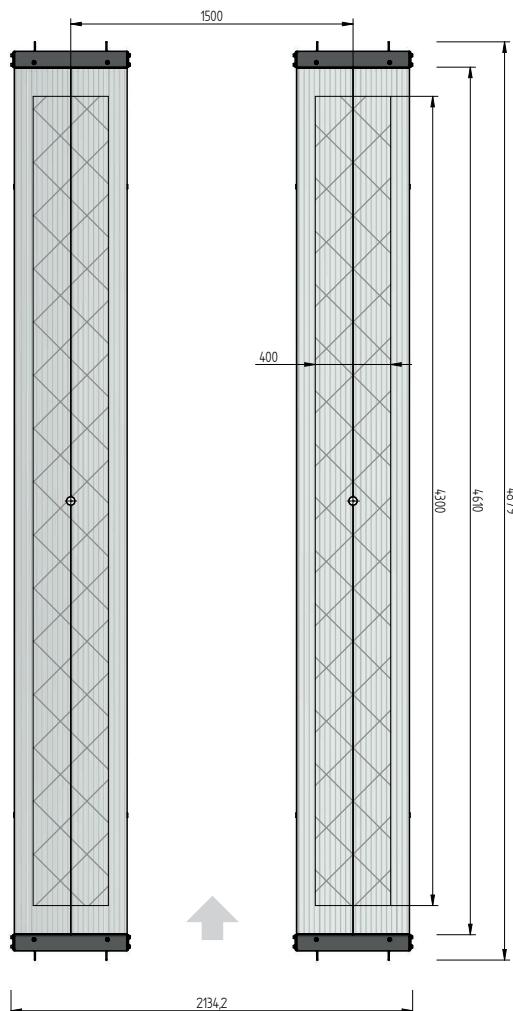

TECHNICAL DATA

capacity	5000 kg
effect. raise height	2019 mm
platform length	4800 mm
platform height	180 mm
piston diameter	123 mm
piston distance	1500 mm
installation depth	2443 mm
motor output	3,0 kW
power connector	400 V/16 A
cable length to control	11 m
lifting time	≈ 35 sec.
lowering time	≈ 35 sec.

Platform support Alu Track 2.50	104980
Installation cassettes STEEL 1500 mm	2030XX
Installation cassettes STEEL 1500 mm galvanized	2031XX
Lifting unit oil 5,0 1500 mm - K	110204
pre-assembled in installation cassette	
Lifting unit oil 5,0 1500 mm - H	110205
packed in wooden box	

ALU TRACK 2.50

ACCESSORIES

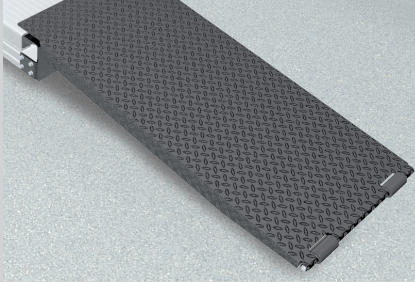

Drive on ramp
1250 mm
102347

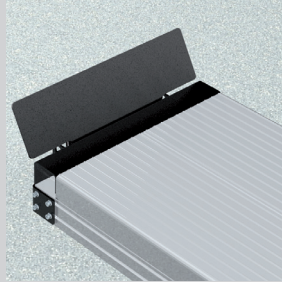

Drive on stop
102349

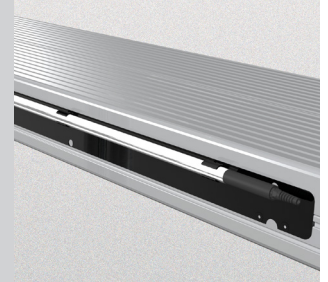

Lighting
LED
102394



Slide rail
4800 mm
102375

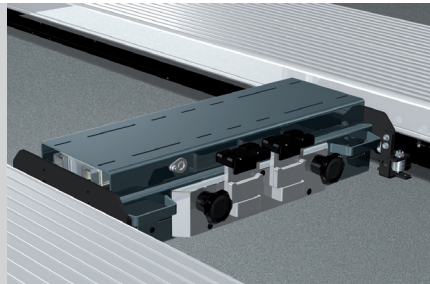

Axle lifter 2600 kg
pneumatic, without slide rails
105063

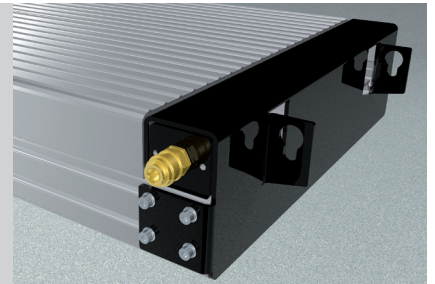

Compressed air supply
102407

Herrmann AG
Bahnhofstrasse 32
D-93483 Pöding

Phone: +49 (0)9461/91388 50
E-Mail: sales@herrmann-lifts.com

www.herrmann-lifts.com

Amendments and mistakes reserved. All illustrations are not binding.

we lift cars