

## SURFACE MOUNTED

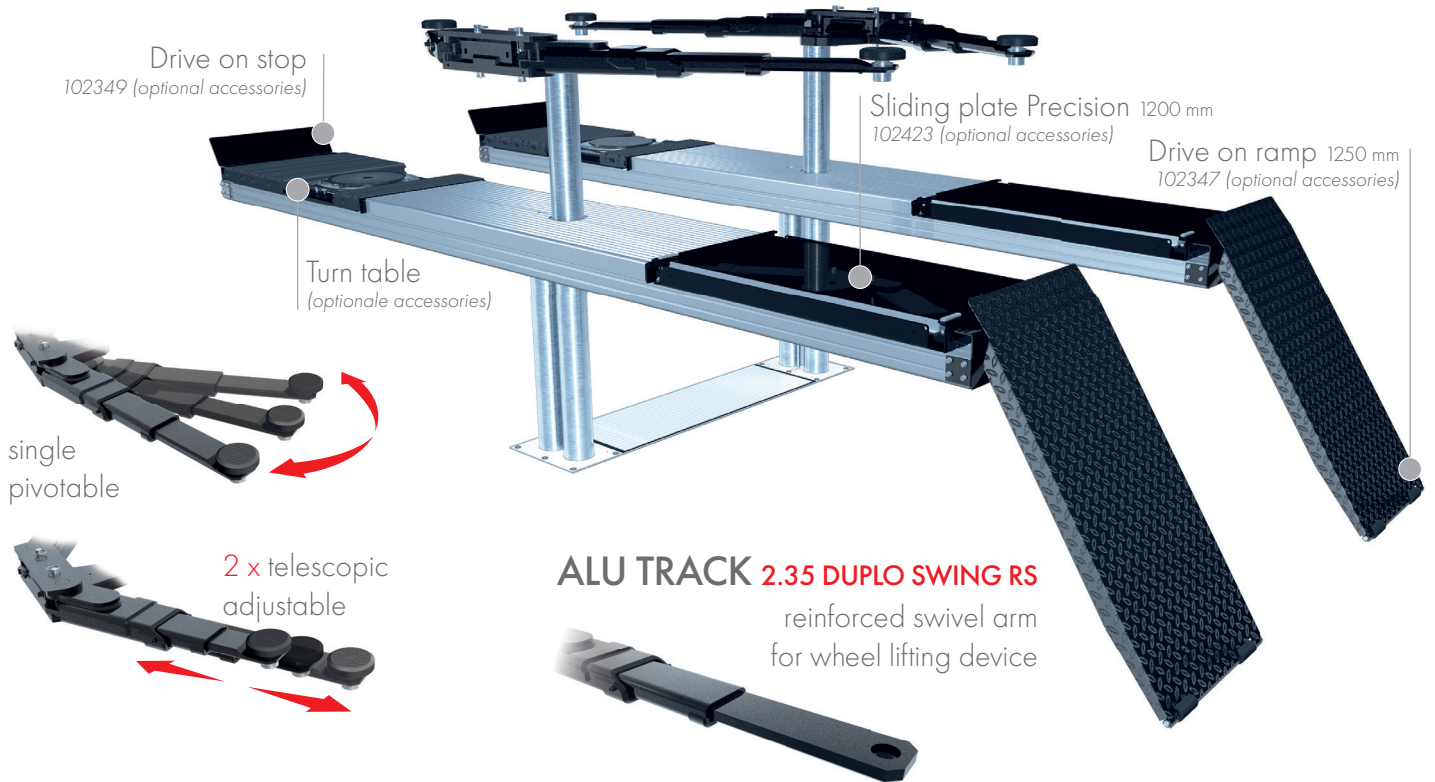

**ALU TRACK 2.35 DUPLO SWING RS**  
reinforced swivel arm  
for wheel lifting device

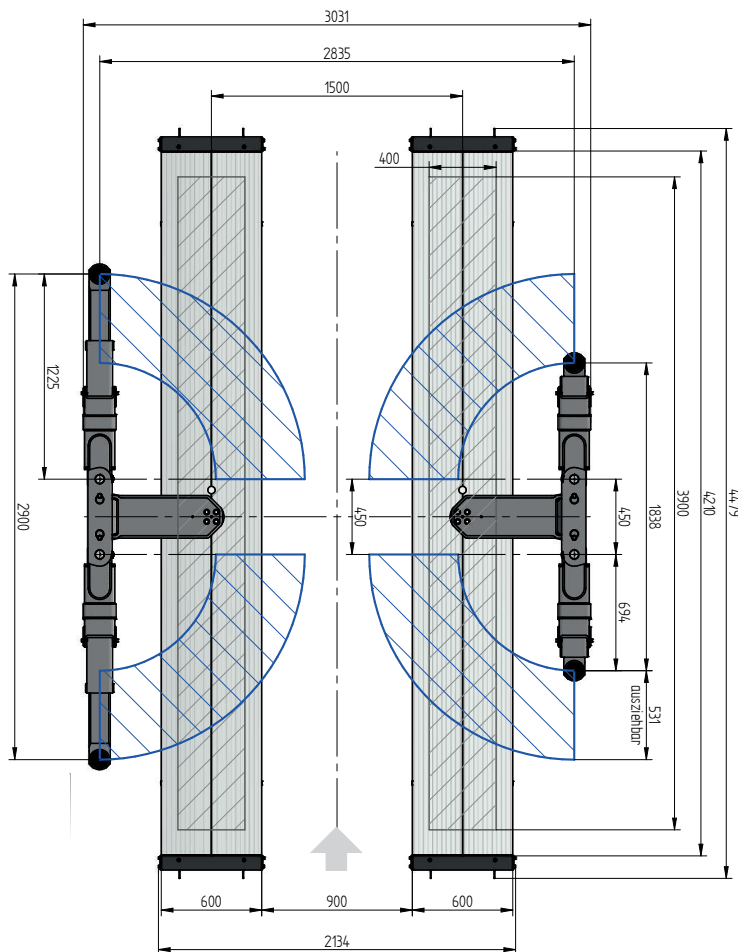

## TECHNICAL DATA

capacity	3500 kg
wheel free lift	3500 kg
effect. raise height platform	2008 mm
effect. raise height wheel free unit	2000 mm
platform length	4400 mm
platform height	180 mm
move in height wheel free unit	90 mm
piston diameter	123 mm
piston distance	1500 mm
installation depth	2443 mm
motor output	3,0 kW
power connector	400 V/16 A
cable length to control	11 m
lifting time	≈ 35 sec.
lowering time	≈ 35 sec.

Platform support Alu Track 2.35 Duplo with platform notches for turn tables and sliding plates	105244
Platform support Alu Track 2.35 Duplo	105336
Support Swingarm 2.35-1500	111579
Support Swingarm 2.35 RS-1500	112128
Installation cassette STEEL 1500 mm	2190XX
Installation cassette STEEL 1500 mm galvanized	2191XX
Lifting unit oil 3,5 t Duplo 1500 mm - K pre-assembled in installation cassette	111599
Lifting unit oil 3,5 t Duplo 1500 mm - H packed in wooden box	111600
Lifting unit oil 3,5 t Duplo 1500 mm - K for wheel free system, pre-assembled in installation cassette	111601
Lifting unit oil 3,5 t Duplo 1500 mm - H for wheel free system, packed in wooden box	111602

# ALU TRACK 2.35 DUPLO SWING

## ACCESSORIES

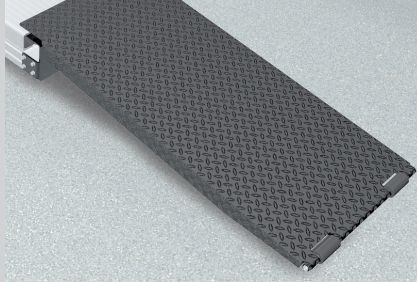

Drive on ramp  
1250 mm  
102347

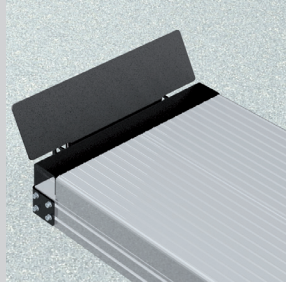

Drive on stop  
102349

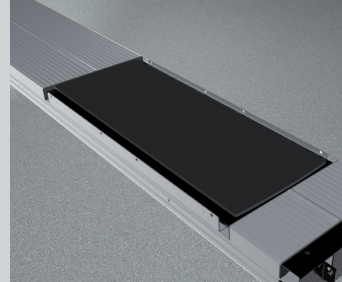

Sliding plate  
Precision 1200 mm  
102423

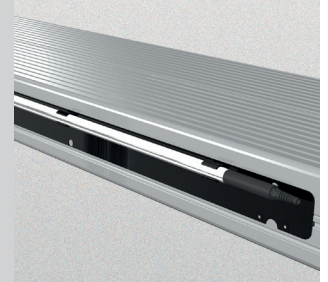

Lighting  
LED  
111598



Slide rail  
4400 mm  
102374



Wheel alignm. supp.  
1350 mm 600 mm  
102377 102381

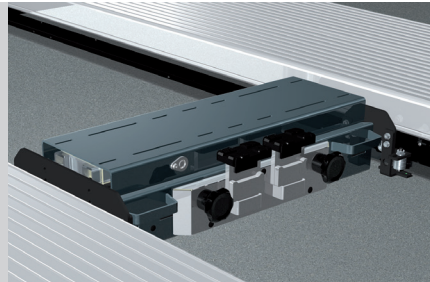

Axle lifter 2600 kg  
pneumatic, without slide rails  
105063

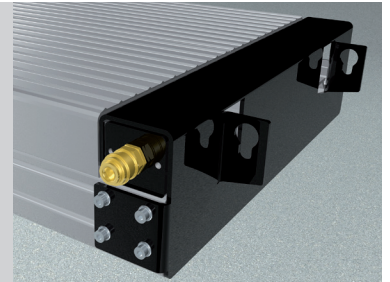

Compressed air supply  
102407



Wheel lifting device  
(1 set / 4 pcs.)

GA490      GA550  
ø wheel 590 - 690 mm    ø wheel 670 - 770 mm  
112051      112052

Mounting adapter

Swingarm RS  
(1 set / 4 pcs.)  
112145

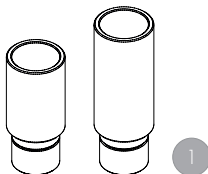

1 Stacking adapter extension  
89 mm      127 mm  
d 50 x 89 mm    d 50 x 127 mm  
109679 (1 Set / 4 Pc.)    109680 (1 Set / 4 Pc.)

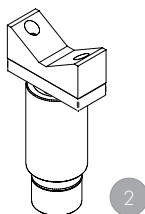

2 Stacking adapter V-shape  
d 50 / 87 - 130 mm  
112107 (1 Set / 4 Pc.)

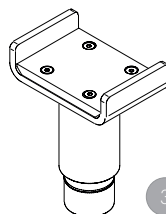

3 Stacking adapter U-form  
d 50  
110397 (1 Set / 4 Pc.)

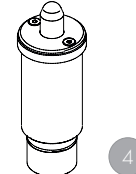

4 Stacking adapter NCV3  
d 50 / 115 - 215 mm  
112100 (1 Set / 2 Pc.)



pushAdapter  
(1 set / 4 pcs.)  
1112530

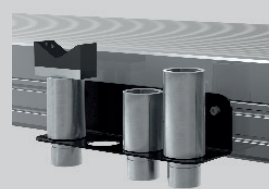

Bracket for stacking-  
adapter extension  
111578

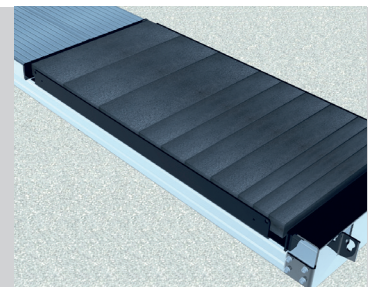

Rubber elements 600 mm  
50 mm    100 mm    200 mm  
111677    111678    111679

Herrmann AG  
Bahnhofstrasse 32  
D-93483 Pöding

+49 (0)9461/91388 50  
sales@herrmann-lifts.com  
www.herrmann-lifts.com