

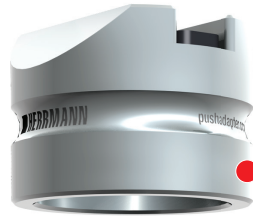

push  
Adapter  
EASY



austauschbare  
Adaptieraufsätze

  
2 x  
schneller

  
sicherer  
Formschluss

  
ø 70 mm  
schlankes Design

  
40 mm  
Federweg

  
austauschbare  
Adaptieraufsätze

  
kompatibel  
einfach nachzurüsten

pushAdapterEASY



ø 40 mm  
ø 45 mm  
ø 50 mm

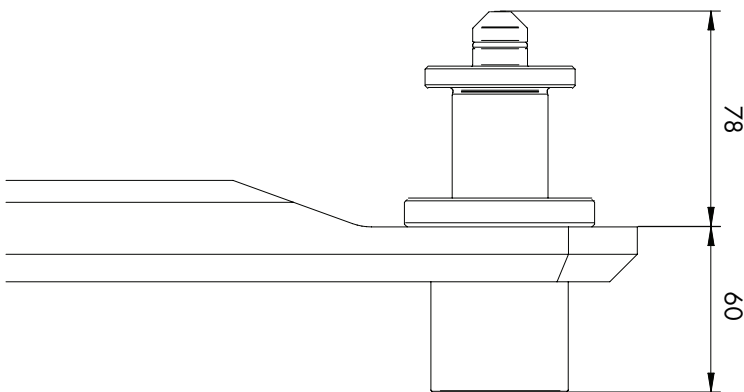

## TECHNISCHE DATEN

Traglast pro Adapter	900 kg
Einschwenkhöhe je nach Aufsatz	120-150 mm
Federweg	40 mm
Durchmesser Aufsätze	ø 40/45/50 mm

pushAdapterEasy ø 50 mm	112703
pushAdapterEasy ø 45 mm	112874
pushAdapterEasy ø 40 mm	112975

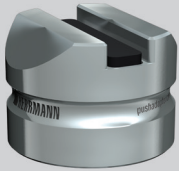

1

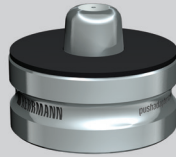

2

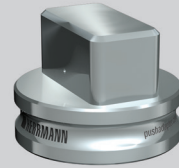

3

1 Adapter-Aufsatz

VW ID.3, VW ID.4, VW ID.5, VW ID.Buzz,  
Cupra Born, Audi Q4 e-tron, Polestar 2,  
Hyundai Kona Elektro  
112533

2 Adapter-Aufsatz

Tesla Model S, Tesla Model 3, Tesla  
Model X, Tesla Model Y  
112534

4 Adapter-Aufsatz

BMW i3, Mercedes EQS  
112535

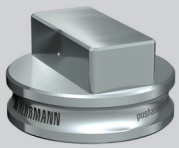

4

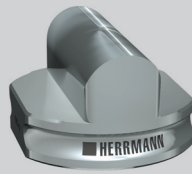

5

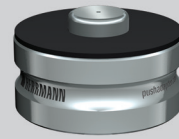

6

4 Adapter-Aufsatz

Audi e-tron GT, Porsche taycan  
112536

5 Adapter-Aufsatz

Audi Q8 e-tron, Audi e-tron GE  
112539

6 Adapter-Aufsatz

Porsche GT Modelle  
112743



Herrmann AG  
Bahnhofstraße 32  
D-93483 Pöding

Telefon: +49 (0)9461/91388 50  
E-Mail: [vertrieb@herrmann-lifts.com](mailto:vertrieb@herrmann-lifts.com)

[www.herrmann-lifts.com](http://www.herrmann-lifts.com)